

Product Name: ZX135CS Samtec Connector Saver - Breakout Adapter BSH – BTH 120 – Page 1 of 2

Product Description: 120pins x 2 rows, 240 pins Samtec Connector Saver - breakout adapter. Offering both BSH and BTH Basic Blade & Beam Samtec connectors on connector saver module with debug access point providing full feature breakout adapter for purpose of test and measurement.

- 1- Each BSH signal is routed to associated BTH connector through board to board via. Pin 1 of BTH is connected to pin 1 of BSH connector.
- 2- All signals have 0.24" (6mm) trace access on both top and bottom layers of the PCB.
- 3- All traces have 10mils (0.26mm) width, enabling soldering of any probe wires (36AWG solid copper – See package includes)
- 4- All traces are 50 Ohms impedance controlled.
- 5- Four, 4, layers PCB design, inner layers are GND planes.
- 6- Accessible GND test points, The test points are connected to module GND planes.
- 7- Offering Extended height BTH connector (0.286" – 7.26mm) , providing interface clearance from host components.
- 8- Mated BSH-BTH (Host with ZX135CS) height 0.315" (8.00mm)
- 9- Ease of interface with single channel and differential scope probes.
- 10- User may relocate any BTH signal by cutting trace before the via and solder to new location or external test equipment.
- 11- Fully compatible with Single Ended , SE, and Differential Pair, DP, Samtec connector BSH BTH series as well as cable assemblies; HQCD , HQDP
- 12- Mates with any height and formfactor BSH BTH connector series such as -DP, -RA, -EM configurations.
- 13- The module is shipped with 12pc of probing wires – See ordering information, see [ZX00BC2PH1](#)

Electrical: Insertion loss > -2dB @8GHz
 Trace impedance: 50 Ω
 Operating Temperature: -55 °C to +125 °C
 Trace width: 10mils (0.254mm)
 Trace to Trace Spacing: 10mils (0.254mm)
 Trace Length: 0.24" (6mm)
 Trace to Trace via: 30mils (0.8mm) from end of PCB trace
 PCB Clearance : 8.0mm from Host PCB (BSH on host)
 36AWG Bare copper wire : 0.042mm diameter - See package includes for details - [ZX00BC2PH1](#)

Application: Manufacturing test and re-use, bringup, testing , debugging

Mates with : Samtec Basic Blade & Beam BTH120 BSH120
 Compatible with – differential Pair (DP), unused signal can be left unconnected or Grounded for improved noise immunity.

Pitch: 0.50mm (0.0197") High Speed connector

- Access:**
- For signal measurements:
 1- Recommendation: Use 36AWG solid copper wire with pin header, see [ZX00BC2PH1](#)
- For signal relocation:
 1- Cut the trace to the connecting via (30 mils [0.8mm] before end of trace)
 2- Using 36AWG solid copper wire, make the required connections. See Signal Access & re-route, **Page 2** (figure "ZX135CS – portion of Top View ").

Compliance:
 ISO2001 certified
 RoHs - Lead Free
 EU RoHS2
 UL E111594 document
 ELV- Vehicle Directive (Directive 2000/EC)
 European Union Directive (203/11/EC)
 Halogen Free per IEC-61249-2.21 : 2003
 RoHs Directive 2011/65/EU
 WEEE Directive (2012/12/EU)

Certificate of Compliance for Radioactive substances
 Certificate of Compliance for Asbestos
 Certificate of Compliance for Ozone Depleting Substances, ODS
 Certificate REACH SVHC
 Certificate of Compliance RoHS_EN_CoC

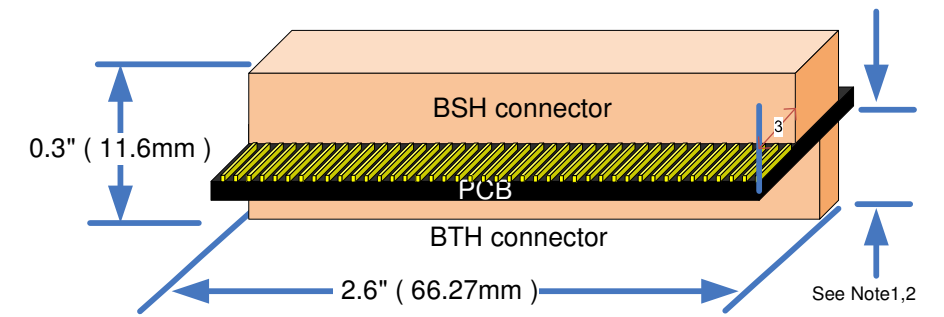

- ZX135CS - Notes:**
- 1- BTH height 0.286" (7.26mm)
 - 2- Mated BTH – BSH height 0.315" (8.00mm)
 - 3- PCB Extends 0.24" (6mm) from the BSH connector

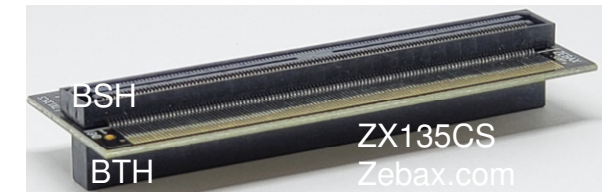

ZX135CS - Simplified Circuit Diagram

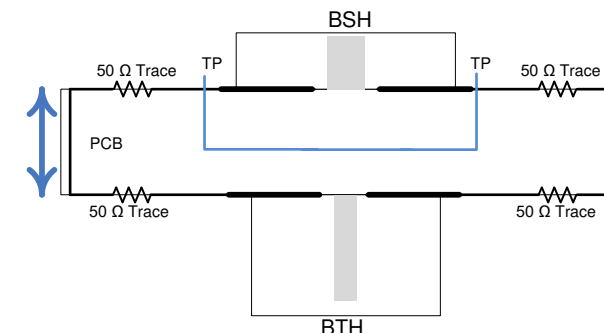

All traces are controlled 50 Ω impedance
 The GND Test Point , has direct connection to inner PCB ground planes

ZX135CS Cross section view

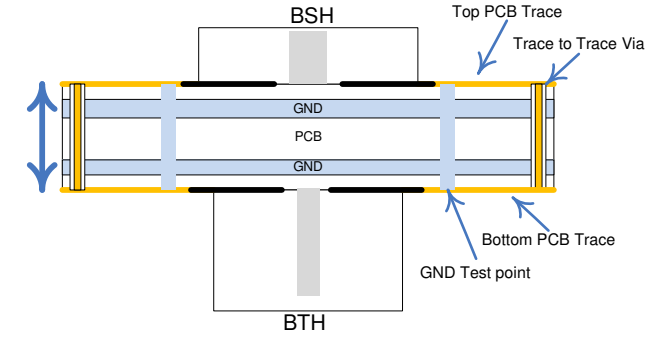

4 Layers PCB design - where 2 inner layers are Ground planes

ZX135CS package includes:

Part number	Quantity	Description
ZX135CS	1	Connector Saver Breakout Adapter module
ZX00BC2PH1	12	36AWG Bare Copper wire to pin header wire assembly

Note : ALL ZEBAX products are RoHS compliant and Lead Free unless otherwise indicated.

ZEBAX TECHNOLOGIES		
SANTA CRUZ, CA U.S.A (831) 222-0717		
WWW.ZEBAX.COM		
SPECIFIED DIMENSIONS ARE INCHES (MM). ROHS COMPLIANT	ASSEMBLY DRAWING	
	ITEM: ZX135CS	
DESCRIPTION: Samtec Connector Saver - breakout adapter BSH BTH 120		
CHECKED: M. MARINA	DRAWN: MATTHEW	REVISION: 1.0
		SHEET: 1 OF 2

Notice

ALL ZEBAX TECHNOLOGIES DESIGN SPECIFICATIONS, DRAWINGS, PUBLICATIONS, AND OTHER DOCUMENTS (TOGETHER AND SEPARATELY, "MATERIALS") ARE BEING PROVIDED "AS IS." ZEBAX MAKES NO WARRANTIES, EXPRESSED, IMPLIED, STATUTORY, OR OTHERWISE WITH RESPECT TO THE MATERIALS, AND EXPRESSLY DISCLAIMS ALL IMPLIED WARRANTIES OF NO INFRINGEMENT, MERCHANTABILITY, AND FITNESS FOR A PARTICULAR PURPOSE.

Information furnished is believed to be accurate and reliable. However, Zebax Technologies assumes no responsibility for the consequences of use of such information or for any infringement of patents or other rights of third parties that may result from its use. Specifications mentioned in this publication are subject to change without notice. This publication replaces all other information previously supplied. Zebax Technologies products are not authorized as in life support devices or systems.

Product Name: ZX135CS Samtec Connector Saver - Breakout Adapter BSH – BTH 120 – Page 2 of 2

Typical Application: ZX135CS is designed for purpose of test and debugging at full connector's bandwidth. It provides new approach in usage of breakout adapters by :

- 1- Utilizing single or differential scope probe.
- 2-Enabling design changes, by re-assignment of any signal by means of cut and solder, where any signal may be cut and assigned to new location by jumper wires.

Scope Probe wire Installation:

- 1- It is recommended to keep the probe wire length at 0.5" (1.2cm) long.
- 2- In order to avoid ground loop problems, please use the shortest Ground probe wire interfacing to the nearest GND reference. ZX135CS provides two GND test points to be utilized as GND reference interface with host.
- 3- Both Keysight as well as Tektronix offer variety of single ended as well as differential probes along with their accessories, below are few probes from each vendor:
 - a) Keysight differential probe or similar N2795A, N2796A, 1168V, 1135B along with E2677B differential Solder-in probe, N5426A ZIF Tip, N2884A Fine Wire ZIF Tip and more – See the figure "probe head accessories".
 - b) Tektronix offers several single-ended as well as differential probes such as : P6245, P6248, P6247, P6246 or any of TDP7000 series and more
- 4- Please follow your vendor's guideline in installation of probe wires & accessories.

Signal Access & re-route:

Re-routing any signal on ZX135CS may be implemented by cutting the trace min. of 30 mils (0.8mm) before end of the trace on top or bottom side of the PCB. The Via (inner connecting via) at end of the trace connects the top layer's signal (trace) to bottom layer's signal (trace).The inner connecting via may not be visible on most of Zebax designs. The via has clearance of 30mils from end of the trace.

ZX135CS module is 4 layers PCB where the inner layers are Ground layers. They are connected to the GND test point . For improved signal integrity, please connect the GND test points to system GND reference point. See Cross Section View figure on Page 1 for details.

Mating and Un-mating:

Uneven or off—angle forces during mating and un-mating of ZX135CS from host or daughter card may cause overstress and damage to the contacts, housing or solder joints. Severe side-to-side rocking motions should be prohibited. Un-mating ZX135CS by lifting one end of the connector (peeling) is permitted. However, this should only be done to initiate separation of the mated contacts at one end of the interfaced connector. The separation angle should be kept as low as possible as the contacts continue to un-mate, thereby spreading out the un-mating forces over the length of the interface connectors. The connectors should not be "peeled" beyond a 20° angle. See Figure below.

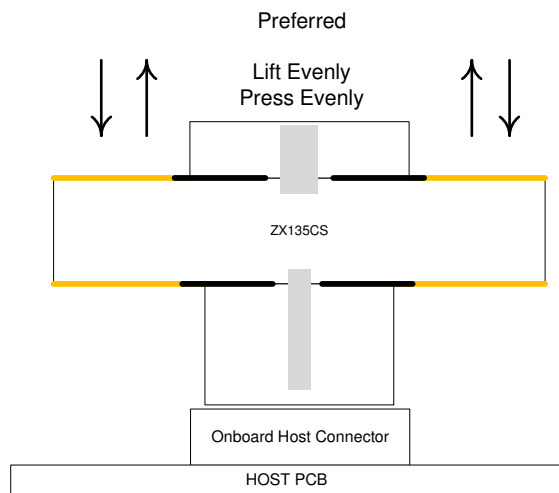

ZX135CS – portion of Top View

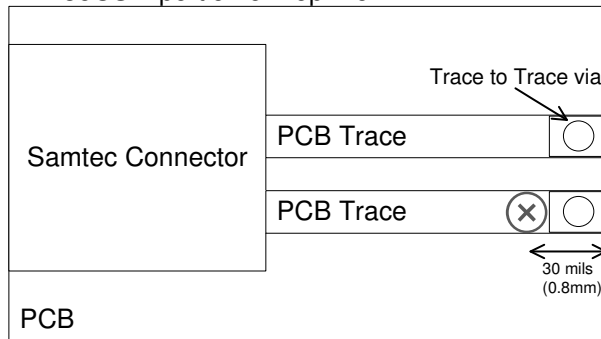

Note: The hole for the Via may not be visible on Zebax Connector Saver breakout adapter designs. The via is located 30 mils (0.8mm) from end of the trace as marked

(X) Ideal location to cut the trace



ZX135CS Top View

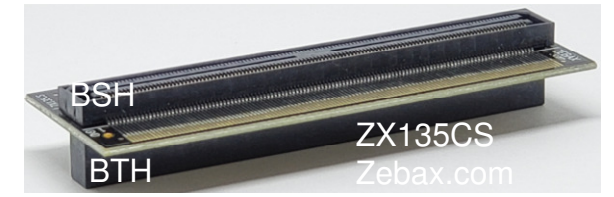

Typical ZX135CS interface with host

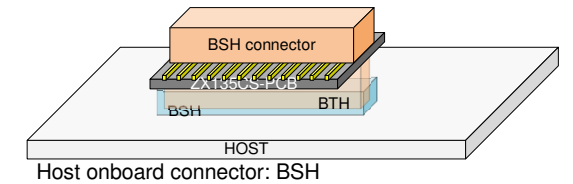

Keysight Probe Head accessories

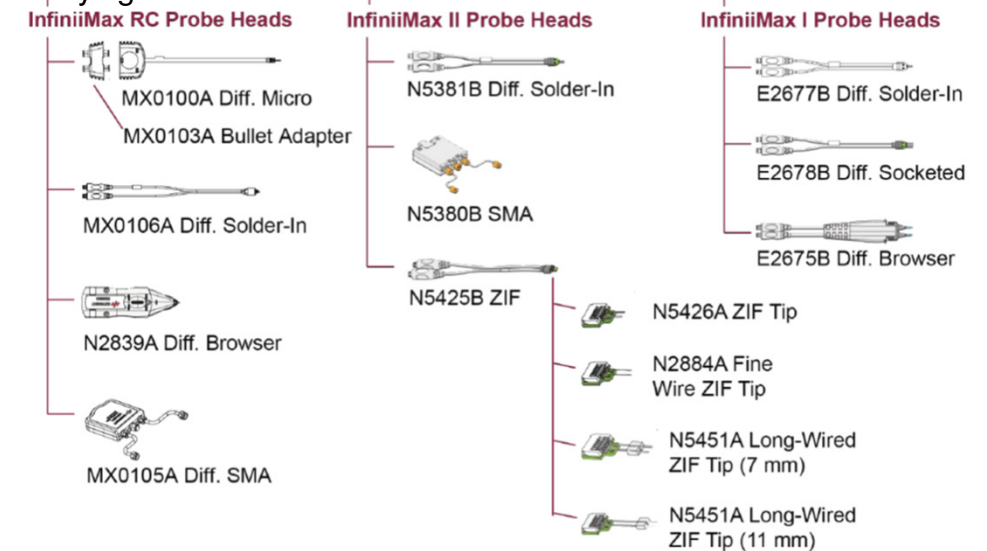

Note : ALL ZEBAX products are RoHS compliant and Lead Free unless otherwise indicated.

ZEBAX TECHNOLOGIES		
SANTA CRUZ, CA U.S.A (831) 222-0717		
WWW.ZEBAX.COM		
SPECIFIED DIMENSIONS ARE INCHES (MM). ROHS COMPLIANT		ASSEMBLY DRAWING
		ITEM: ZX135CS
DESCRIPTION: Samtec Connector Saver - breakout adapter BSH BTH 120		
CHECKED: M. MARINA	DRAWN: MATTHEW	REVISION: 1.0
		SHEET: 2 OF 2

Notice

ALL ZEBAX TECHNOLOGIES DESIGN SPECIFICATIONS, DRAWINGS, PUBLICATIONS, AND OTHER DOCUMENTS (TOGETHER AND SEPARATELY, "MATERIALS") ARE BEING PROVIDED "AS IS." ZEBAX MAKES NO WARRANTIES, EXPRESSED, IMPLIED, STATUTORY, OR OTHERWISE WITH RESPECT TO THE MATERIALS, AND EXPRESSLY DISCLAIMS ALL IMPLIED WARRANTIES OF NO INFRINGEMENT, MERCHANTABILITY, AND FITNESS FOR A PARTICULAR PURPOSE.

Information furnished is believed to be accurate and reliable. However, Zebax Technologies assumes no responsibility for the consequences of use of such information or for any infringement of patents or other rights of third parties that may result from its use. Specifications mentioned in this publication are subject to change without notice. This publication replaces all other information previously supplied. Zebax Technologies products are not authorized as in life support devices or systems.