

HDMI ZX201S Test board

Test case using ZX201S at HDMI 4Kx2K & 1080p resolution :

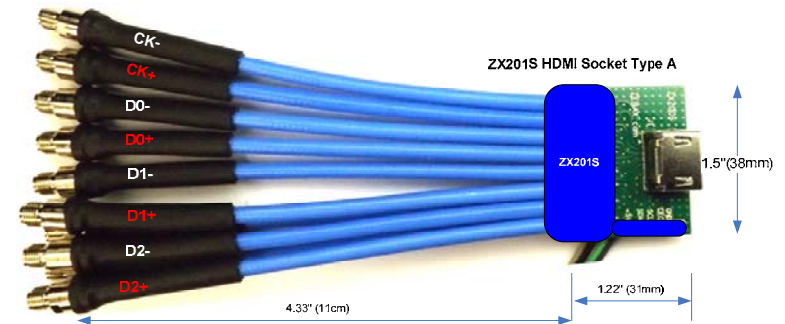

Test Module: **ZX201S**

Test Case : **1080p** and **4K x 2K 30 Hz PRN**
HDMI Clock Frequency: **1.65GHz .. 3.4GHz**

The followings are test results using ZX201S test board

HDMI ZX201S Test board

1. Signal is applied to all TMDS channels.
2. BERT PRBS: 2^7-1
3. BERT Signal Output Voltage : 0.5Vp-p

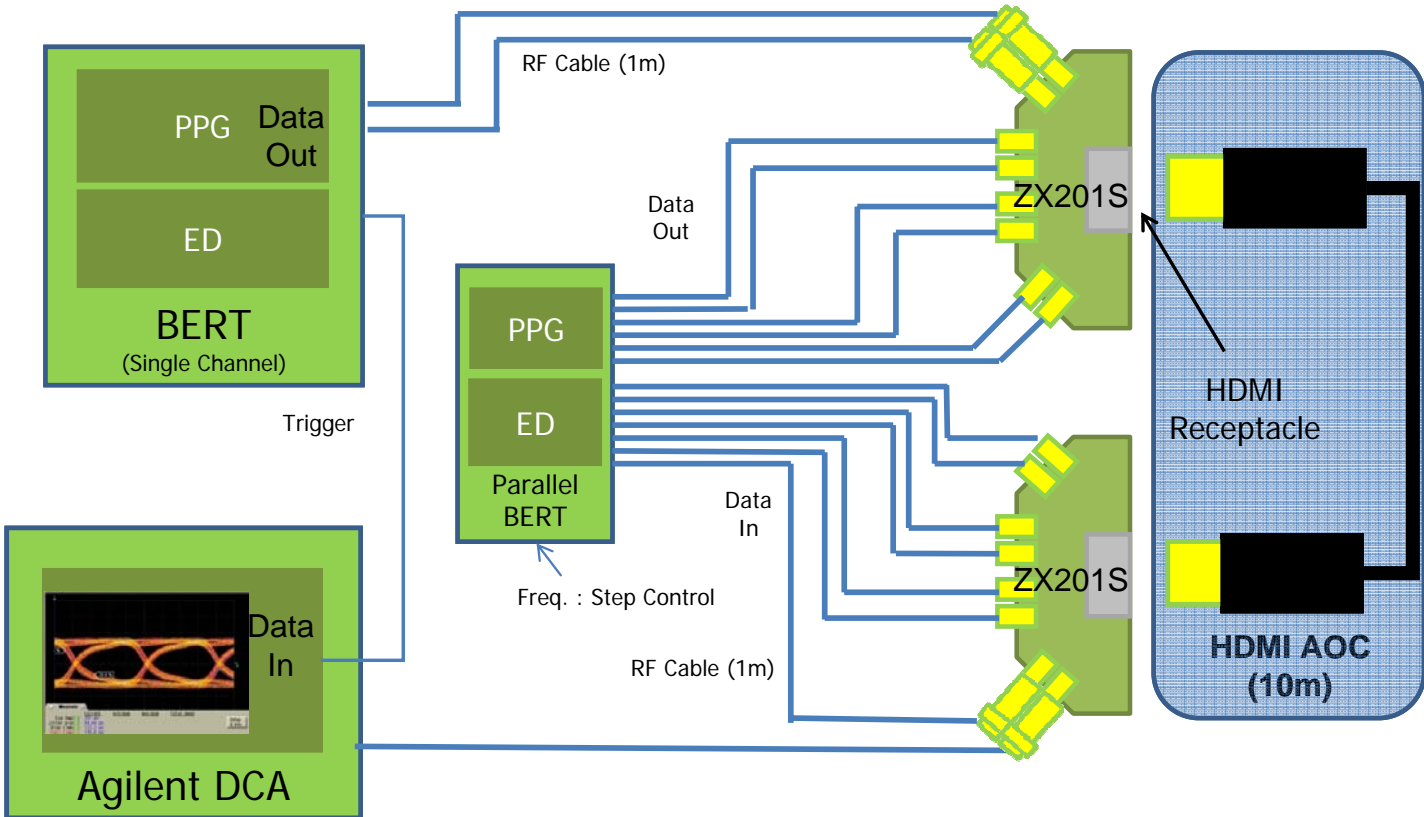

*AOC: Active Optical Cable

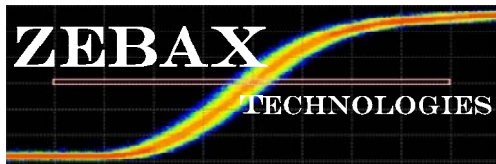

HDMI ZX201S Test board

- Modulation Freq. : **1.65Gbps** <- 1080p resolution - 165MHz x 10



- Modulation Freq. : **2.23Gbps** <- 1080p 12bit Deep color resolution - 185MHz x 12

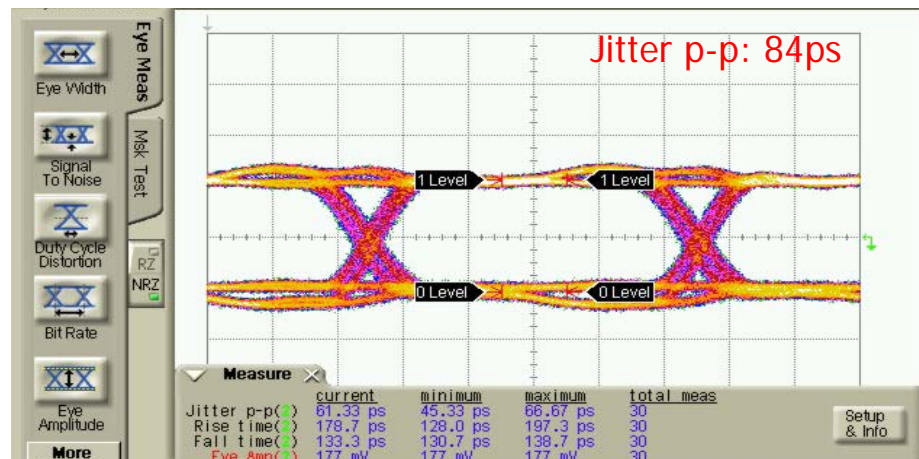

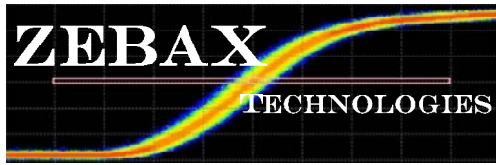

HDMI ZX201S Test board

- Modulation Freq. : **2.5Gbps** 4K x 2K resolution 4K x 2K

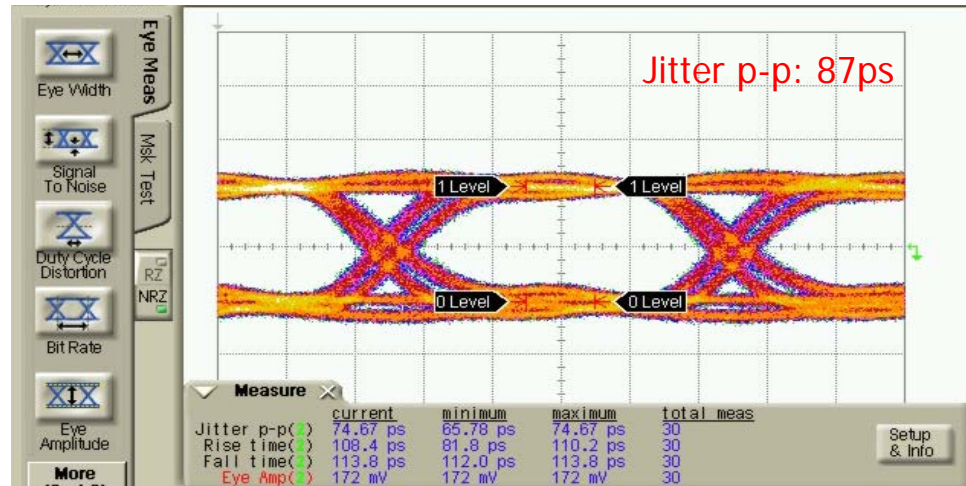

- Modulation Freq. : **2.97Gbps** 4K x 2K resolution

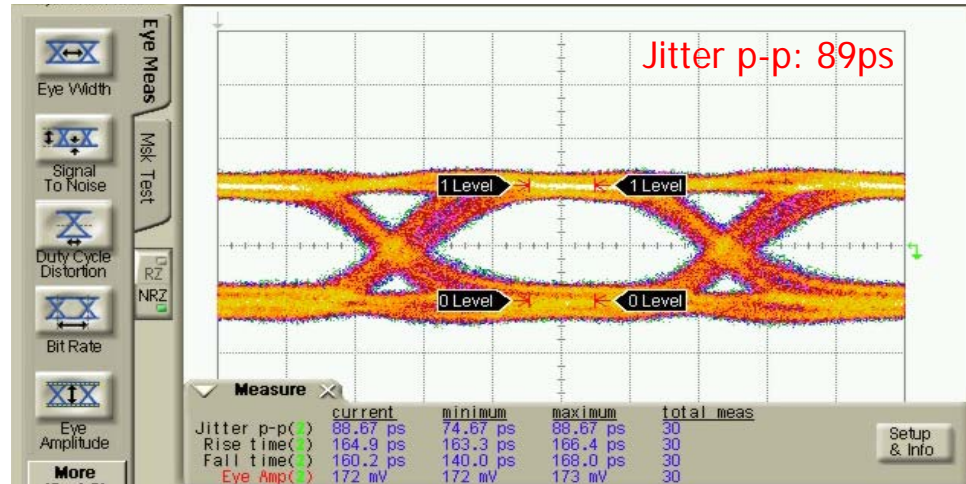

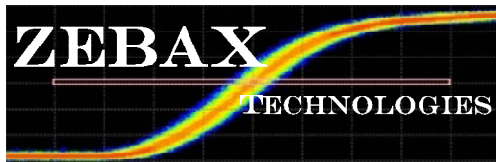

HDMI ZX201S Test board

- Modulation Freq. : **3.4Gbps** 4K x 2K resolution

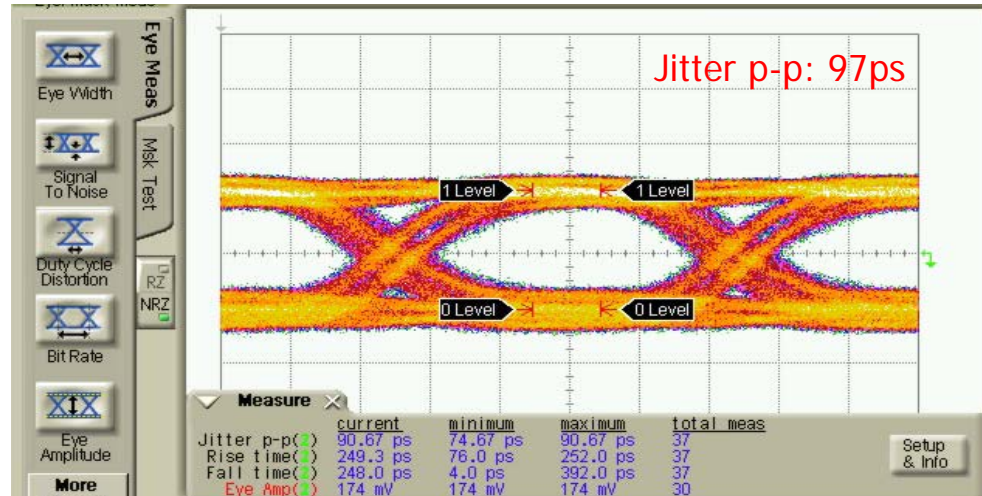

Conclusion

- ZX201S meets HDMI TPA-R SE DI cable electrical test requirement.