

Product Name: ZX134CS Samtec Connector Saver - Breakout Adapter BSH – BTH 090

Product Description: 90 pins x 2 rows, 90 pins Samtec Connector Saver - breakout adapter. Offering both BSH and BTH connectors on connector saver module with debug access point providing full feature breakout adapter.

- 1- Each BSH signal is routed to associated BTH connector through board to board via. Pin 1 of BTH is connected to pin 1 of BSH connector.
- 2- All signals have 0.24" (6mm) trace access on both top and bottom layers of the PCB.
- 3- All traces are 50 Ohms impedance.
- 4- Four, 4, layers PCB design, inner layers are GND planes.
- 5- Accessible GND test points, The test points are connected to module GND planes.
- 6- Offering Extended height BTH connector (0.286" – 7.26mm) , providing interface clearance from host components.
- 7- Mated BSH-BTH (Host with ZX134CS) height 0.315" (8.00mm)
- 8- Ease of interface with single channel and differential scope probes.
- 9- User may relocate any BTH signal by cutting trace before the via and solder to new location or external test equipment.
- 10- Fully compatible with Single Ended , SE, and Differential Pair, DP, Samtec connector BSH BTH series as well as cable assemblies; HQCD , HQDP .

Application: Manufacturing test and re-use, bringup, testing , debugging

Mates with : Samtec BTH090 BSH090 BSH020(DP) BTH020(DP)
Compatible with – differential Pair (DP), unused signal can be left unconnected or Grounded for improved noise immunity.

Pitch: 0.50mm (0.0197") High Speed connector

Access: All traces are 10mils (0.26mm) wide with 0.24" (6mm) length.

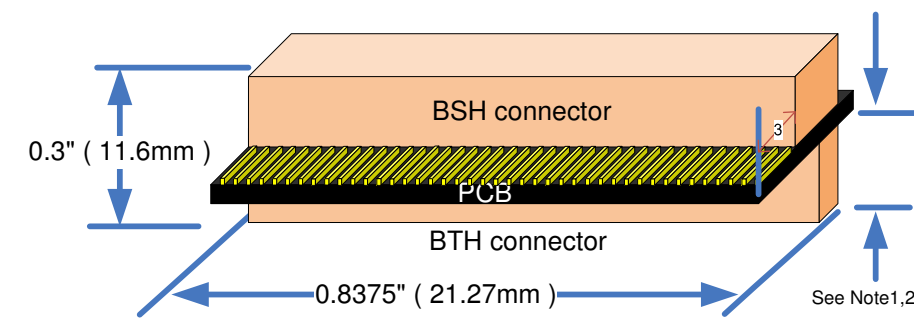

- Notes:
- 1- BTH height 0.286" (7.26mm)
 - 2- Mated BTH – BSH height 0.315" (8.00mm)
 - 3- PCB Extends 0.24" (6mm) from the BSH connector

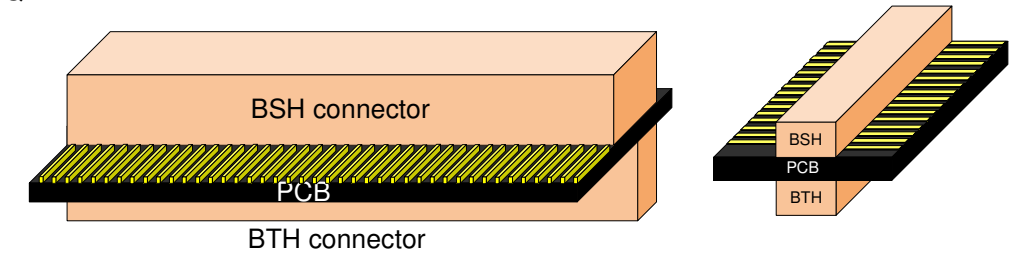

Simplified Block Diagram

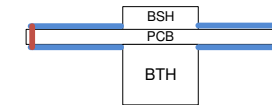

- 1- BSH & BTH connector pins are extended by 0.24" (6mm) to edge of the PCB.
- 2- Via at edge of the PCB , connects the top BSH pins to bottom BTH pins via extended PCB traces.
- 3- User may relocate any BTH signal to any BSH signal pin by cutting trace before the via and solder the pin to new location.
- 4- Scope probe wire as well as differential scope probe may be soldered to the traces for ease of test and measurement.
- 5- All traces are 10mils (0.26mm) wide.

Note
ALL ZEBAX products are RoHS compliant and Lead Free unless otherwise indicated.

Picture below exhibits ZX134CS interface with host, enabling scope probe access. Typically HOST has onboard BSH connector.

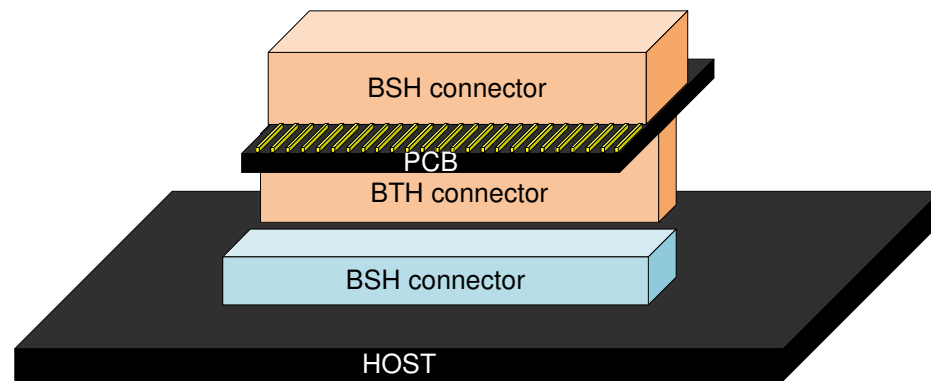

Compliance:

- ISO2001 certified
- RoHs - Lead Free
- EU RoHS2
- UL E111594 document
- ELV- Vehicle Directive (Directive 2000/EC)
- European Union Directive (203/11/EC)
- Halogen Free per IEC-61249-2.21 : 2003
- RoHs Directive 2011/65/EU
- WEEE Directive (2012/12/EU)

- Certificate of Compliance for Radioactive substances
- Certificate of Compliance for Asbestos
- Certificate of Compliance for Ozone Depleting Substances, ODS
- Certificate REACH SVHC
- Certificate of Compliance RoHS_EN_CoC

Notice

ALL ZEBAX TECHNOLOGIES DESIGN SPECIFICATIONS, DRAWINGS, PUBLICATIONS, AND OTHER DOCUMENTS (TOGETHER AND SEPARATELY, "MATERIALS") ARE BEING PROVIDED "AS IS." ZEBAX MAKES NO WARRANTIES, EXPRESSED, IMPLIED, STATUTORY, OR OTHERWISE WITH RESPECT TO THE MATERIALS, AND EXPRESSLY DISCLAIMS ALL IMPLIED WARRANTIES OF NO INFRINGEMENT, MERCHANTABILITY, AND FITNESS FOR A PARTICULAR PURPOSE.

Information furnished is believed to be accurate and reliable. However, Zebax Technologies assumes no responsibility for the consequences of use of such information or for any infringement of patents or other rights of third parties that may result from its use. Specifications mentioned in this publication are subject to change without notice. This publication replaces all other information previously supplied. Zebax Technologies products are not authorized as in life support devices or systems.

ZEBAX TECHNOLOGIES		
SANTA CRUZ, CA U.S.A (831) 222-0717		
WWW.ZEBAX.COM		
SPECIFIED DIMENSIONS ARE INCHES (MM). ROHS COMPLIANT	ASSEMBLY DRAWING	
	ITEM: ZX134CS	
DESCRIPTION: Samtec Connector Saver - breakout adapter BSH BTH 090		
CHECKED: M. MARINA	DRAWN: SLAVIK	REVISION: 1.0
		SHEET: 1 OF 1